

ProGUARD DP® Corner Installation Guide (option2) (Steel Stud Substrate)

Step 1: Inspect Framed Walls

Steel studs shall be installed plumb and level.
Deflection criteria for substrate should be L/600 (L/720 preferred).

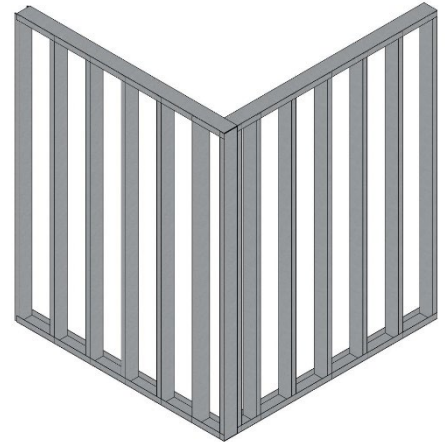

Step 2: Install Sheathing

Install exterior grade sheathing (i.e. glass-mat reinforced gypsum board, plywood etc...) per manufacturer's recommendations with proper screw placement and attachment.

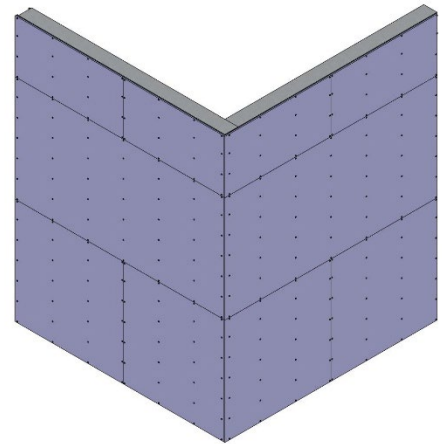

Step 3: Waterproof Joints in Exterior Grade Sheathing

Apply a liberal coat of ProGUARD DP® Water Armor Air and Water Barrier (Vapor Permeable) or Water Armor VB (Vapor Retarder/Barrier) to the joints between the exterior grade sheathing boards and then embed the ProGUARD DP® Water Armor Flashing Tape into it. Once the tape is applied, apply another liberal coat of ProGUARD DP® Water Armor Air and Water Barrier or Water Armor VB over the flashing tape and allow it all to cure per T.Clear's recommendations.

or

Apply a liberal coat of Laticrete Air & Water Barrier (Vapor Retarder) or Laticrete Air Barrier C3 (Vapor Permeable) to the joints between the exterior grade sheathing boards and then embed the Laticrete Waterproofing/Anti-Fracture Fabric into it. Once the Anti-Fracture Fabric is applied, apply another liberal coat of Laticrete Air & Water Barrier or Laticrete Air Barrier C3 over the Anti-Fracture Fabric and allow it all to cure per Laticrete's recommendations.

Regardless of the method being used, properly seal around any penetrations or openings such as recesses, chases, pipes, door and window openings etc... Refer to the respective waterproofing membrane instructions for methods to achieve proper seals.

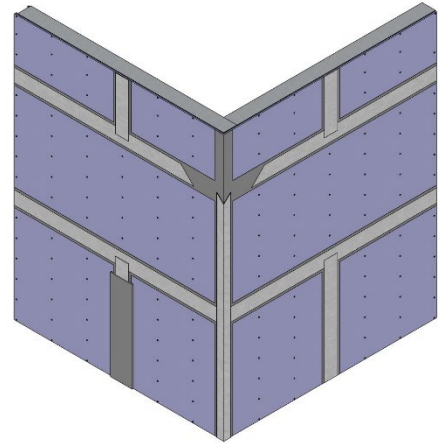

ProGUARD DP® Corner Installation Guide (option2) (Steel Stud Substrate)

Step 4: Install Air & Water Barrier

Apply the required number of coats of ProGUARD DP® Water Armor Air and Water Barrier (Vapor Permeable) or Water Armor VB (Vapor Retarder/Barrier) over the entire surface of the sheathing. Follow T.Clear's instructions for proper application and number of coats.

or

Apply the required number of coats of Laticrete Air and Water Barrier (Vapor Retarder) or Laticrete Air Barrier C3 (Vapor Permeable) over the entire surface of the sheathing. Follow Laticrete's instructions for proper application and number of coats.

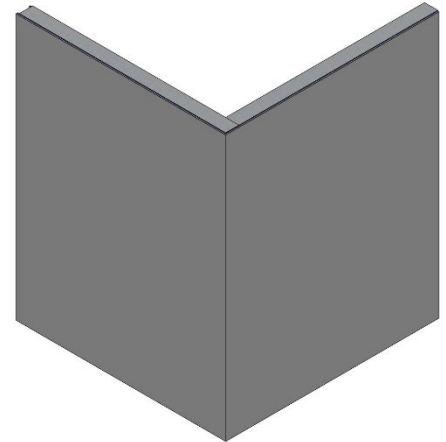

Step 5: Base Wall Flashing/Panel Support

Install 16-gauge steel flashing/panel support (**supplied by others**), ideally prefinished or with a G-90 coating at the base of walls, above wall openings, and at deflection joints in the wall assembly. Attach the steel flashing at 16" O.C. back to the studs or solid substrate behind, using the same screws used to attach the ProGUARD DP® insulated concrete panels (shorter versions of the ProGUARD DP® Silver C Screws). The steel flashing should extend 4" up the wall and the horizontal leg should project approximately 1/2" beyond the face of the ProGUARD DP® insulated concrete panel face (i.e. depth of the horizontal leg is based on the thickness of the ProGUARD DP® insulated concrete panels plus 1/2"). If the panels are resting on the foundation ledge or 16-gauge steel flashing/panel support is used, then this would be a ProGUARD DP® "**supported panel application**" (i.e. base of ProGUARD DP® is supported from underneath in addition to the support provided by the screws).

16-gauge steel flashing/panel support does not have to be utilized. If not used, then this would be a ProGUARD DP® "**unsupported panel application**". In this case, we suggest a light gauge prefinished bent metal flashing to direct moisture out of the assembly. With an unsupported assembly, more screws with a tighter screw spacing may be required to fasten the ProGUARD DP® insulated concrete panels to the substrate. In either case, the engineer of record should provide this information by referring to NTA Report TRIG030116-28.

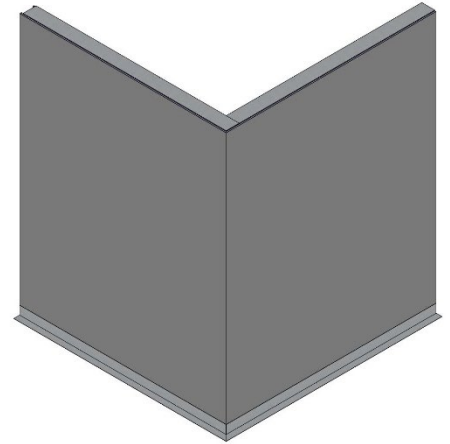

Step 6: Base Wall Flashing

Apply T.Clear Water Armor LF using a sausage gun and squeeze a generous amount of the flashing material on to the horizontal and vertical legs of the steel flashing/panel support and up the wall a few inches and then spread/flatten over the surface with a plastic putty knife ensuring proper coverage and all elements are completely sealed. Alternatively, apply a liberal coat of ProGUARD DP® Water Armor Air and Water Barrier (Vapor Permeable) or Water Armor VB (Vapor Retarder/Barrier) up the vertical leg of the steel flashing/panel support and up the wall a few inches and then embed the ProGUARD DP® Water Armor Flashing Tape into it ensuring to cover the top edge of the steel flashing/panel support. Once the tape is applied, apply another liberal coat of ProGUARD DP® Water Armor Air and Water Barrier or Water Armor VB over the flashing tape and steel flashing/panel support and allow it all to cure per T.Clear's recommendations.

or

Apply Laticrete Flashing Sealant using a sausage gun and squeeze a generous amount of the flashing material on to the horizontal and vertical legs of the steel flashing/panel support and up the wall a few inches and then spread/flatten over the surface with a plastic putty knife ensuring proper coverage and all elements are completely sealed. Alternatively, apply a liberal coat of Laticrete Air & Water Barrier (Vapor Retarder) or Laticrete Air Barrier C3 (Vapor Permeable) up the vertical leg of the steel flashing/panel support and up the wall a few inches and then embed the Laticrete Waterproofing/Anti-Fracture Fabric into it ensuring to cover the top edge of the steel flashing/panel support. Once the Anti-Fracture Fabric is applied, apply another liberal coat of Laticrete Air & Water Barrier or Laticrete Air Barrier C3 over the Anti-Fracture Fabric and steel flashing/panel support and allow it all to cure per Laticrete's recommendations.

Regardless of the method being used, properly seal around any penetrations or openings such as recesses, chases, pipes, door and window openings etc... Refer to the respective waterproofing membrane instructions for methods to achieve proper seals.

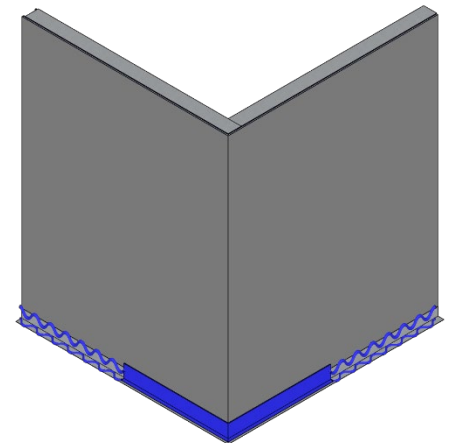

ProGUARD DP® Corner Installation Guide (option2) (Steel Stud Substrate)

Step 7: Cut Out Insulation from First Panel to Slide into Second Panel

Prior to installation of the ProGUARD DP® insulated concrete board panels at corner conditions, one ProGUARD DP® panel edge should be ship-lapped by notching and removing the foam from the back of one of the panel edges that will be located at the corner so that one panel can dovetail into the other. Foam removal to create the ship-lapped edge can be done with an electric hot-knife or circular saw. If cutting with a circular saw be sure to set depth gauge so that the blade does not cut through the back face of the concrete board. As the installation of the ProGUARD DP® panels continues up the wall at the corners repeat this step by notching the foam and alternating the ship-lapping from one side to the other with each successive course.

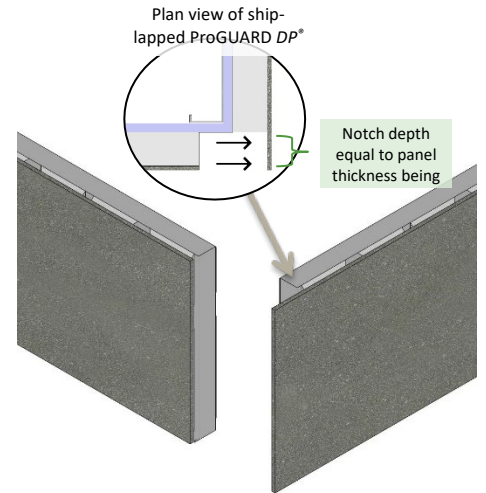

Step 8: Install First ProGUARD DP® Insulated Concrete Base Weep Panels

Install the first ProGUARD DP® Base Weep Panel onto the foundation wall or steel flashing/panel support and over the steel flashing/panel support above windows. Ensure that the vertical panel joints fall on a stud. Panels may have to be cut to length to accomplish this. Due to standard stud spacing the panels are typically set with the 8'-0" dimension in the horizontal direction on the wall, although in certain instances it may be prudent to stand the panels up vertically (pilasters, columns etc...). ProGUARD DP® panels can be installed horizontally or vertically, as the drainage planes will function in either direction.

Engineer of record should select ProGUARD DP® Silver C screws and screw spacing using NTA Report TRIG030116-2. Screw spacing will be dependent on supported or unsupported panel applications, weight of the thin adhered masonry veneer or stucco application, insulation thickness, wind pressure, and wind speed. When fastening the ProGUARD DP® panels, the screw heads should not break the outer embedded mesh of the concrete board.

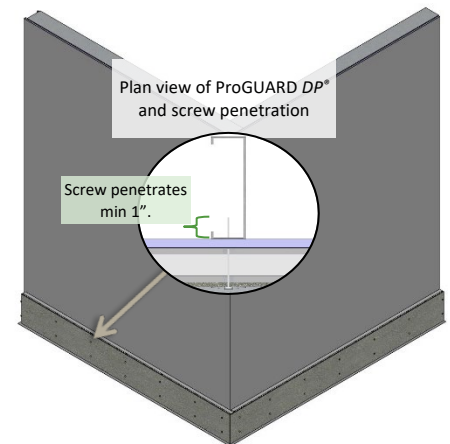
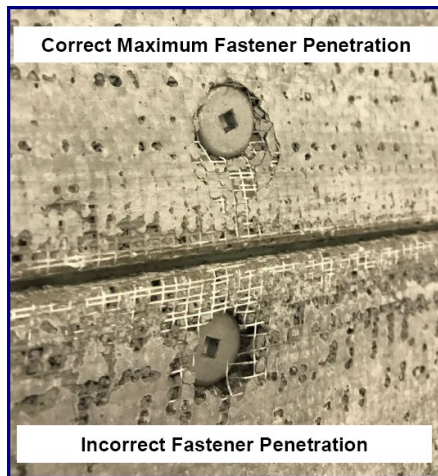

Ensure screw length selected allows for a minimum of 1" penetration into the stud structural back-up behind the sheathing. Calculation for minimum screw length:

$$\text{ProGUARD DP® Panel Thickness} + \text{exterior grade sheathing thickness} + 1" \\ (\text{select next longest standard fixed screw length})$$

Please call Arriscraft Technical Services if there are any questions about the screws or screw spacing. **Only use approved ProGUARD DP® Silver C screws and do not substitute with any other screw as this will void the warranty.**

ProGUARD DP® Corner Installation Guide (option2) (Steel Stud Substrate)

Step 9: Install Remaining ProGUARD DP® Panels

Once the ProGUARD DP® Base Weep Panels are installed the first row of ProGUARD DP® panels can be installed above, offsetting the vertical panel joints in increments of at least 16" minimum (i.e. 16", 32", 48" etc...). The drainage grooves do not need to be aligned.

Remember to notch the foam and alternate the ship-lapping at the corners from one side to the other with each successive course.

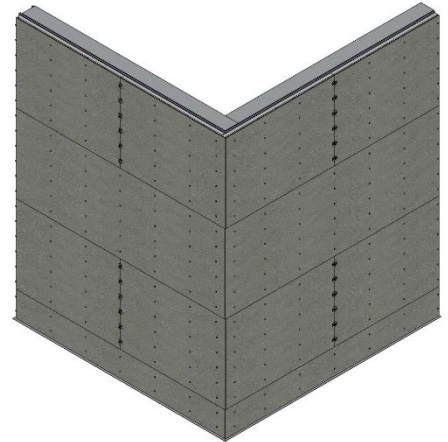

Step 10: Screws at Panel Joints

ProGUARD DP® Silver C screws in combination with Silver C Non-Barb Plate Washers should be utilized at the vertical panel joints only. When fastening the ProGUARD DP® panels, the screw heads and washers should not break the outer embedded mesh of the concrete board.

NOTE: WASHERS ARE ONLY TO BE USED IN COMBINATION WITH THE SCREWS IN THE VERTICAL JOINTS BETWEEN PANELS. WASHERS USED IN ANY OTHER LOCATION WITHIN THE ASSEMBLY WILL VOID THE PRODUCT SPECIFIC MATERIAL AND SYSTEM WARRANTIES.

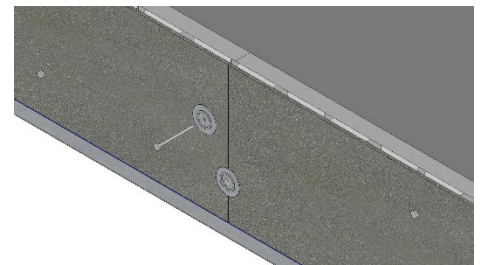

Step 11: Concrete Board Panel Joint Treatment

Once all ProGUARD DP® panels are installed, treat all joints between panels with the **BLUE** self-adhering 4" wide alkali-resistant mesh tape. Apply tape across all joints (2" on either side of joint), pressing firmly to ensure adhesion to substrate. Spread a thin coat of T.Clear Total Bond or Laticrete Bonding Mortar (select appropriate bonding mortar for application, refer to checklists below) over the alkali resistant mesh tape. Allow bonding mortar to fully cure.

Continue this process until all the joints between all ProGUARD DP® panels have been treated, including at corners, opening jambs, sills, and headers etc... Allow bonding mortar to fully cure.

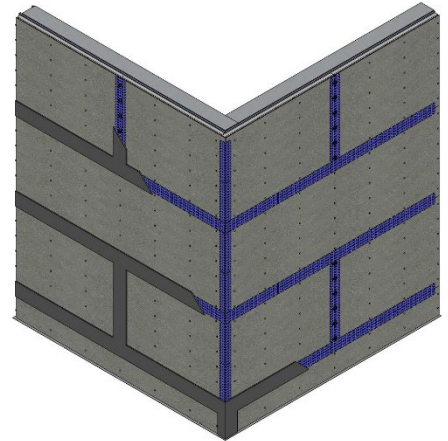

Step 12: Adhered Veneer Substrate Preparation

Ensure installed ProGUARD DP® insulated concrete panels are free of dust and debris. Using a notched trowel, spread T.Clear Total Bond or Laticrete Bonding Mortar across ProGUARD DP® panels and ensuring to burn the mortar into the concrete board surface. Pull the notched side of the trowel across mortar to create a grooved surface and to gauge the mortar thickness. Notched trowel selection is dependent on the material being installed and the substrate tolerances. Apply only a workable area of mortar that will allow stone/brick/masonry to be properly set before surface drying occurs. This area will vary depending on site environmental conditions.

NOTE: Do not substitute Laticrete or T.Clear Bonding Mortars with any other products or materials unless Arriscraft Technical Services has been consulted.

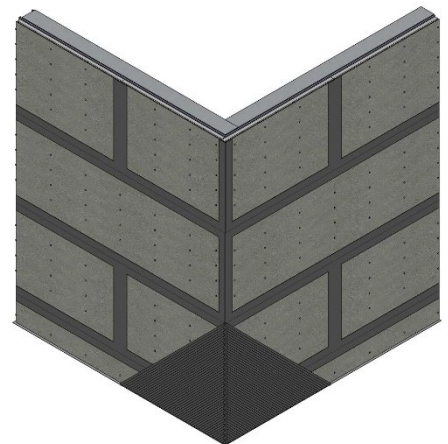

ProGUARD DP® Corner Installation Guide (option2) (Steel Stud Substrate)

Step 13: Prepare Thin Adhered Masonry Veneer

Clean unit backs of any dust, laitance, loose material and any excess film that could impede bond. "Back-butter" the thin-adhered units with T.Clear Total Bond or Laticrete Bonding Mortar, ensuring to burn the mortar into the back of the units and filling any surface irregularities. Pull notched side of the trowel across mortar to create a grooved surface and to gauge the mortar thickness. Notched trowel selection is dependent on the material being installed and the tolerances of the substrate. Be sure to achieve 100% coverage with the mortar.

NOTE: Do not substitute Laticrete Bonding Mortars or T.Clear Bonding Mortars with any other products or materials unless Arriscraft Technical Services has been consulted.

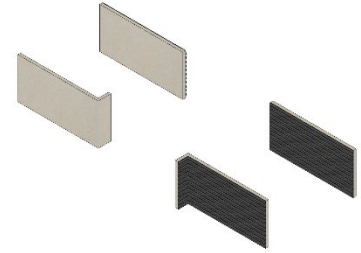

Step 14: Install Thin Adhered Masonry Veneer

Begin with the corner pieces and bring the two still wet mortar surfaces together (back buttered units and mortar on the wall is in part what creates the incredible bond strengths). Press the corner piece onto the wall, rotating back and forth slightly. This process should force some of the mortar to "squeeze out" and work out any air gaps in the mortar. Remove any excess mortar with a square flat trowel and use the excess on the next piece of thin-adhered masonry.

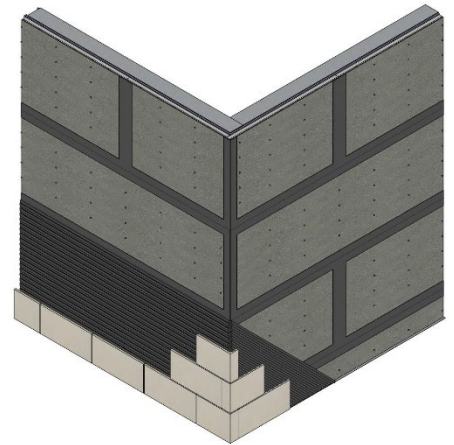

Step 15: Install Thin Adhered Masonry Veneer

After the corner pieces are installed, apply flat stretcher pieces starting at an outside corner unit and working your way in. Set the stretcher units by placing it on the ledger, steel flashing/panel support, or the units that were installed below. Once set on the wall push the unit into the mortar and up and at an angle and then return it back to the desired position. This process should force some of the mortar to "squeeze out" and work out any air gaps in the mortar. Remove any excess mortar with a square flat trowel and use the excess on the next unit. Remove excess mortar droppings from the veneer face with a clean wet sponge and a stiff fibre brush. Check for 100% mortar coverage by removing ten brick units, 4 ARRIS-tile, natural stone, or porcelain tile units, 8 manufactured stone units from the wall per bag of mortar used to check that no voids exist. Reinstall removed units.

Once the Bonding Mortar has cured then use the Laticrete Pointing Mortar or a Type "N" pointing mortar to point the joints between the individual units as required. Place pointing mortar into a grout bag or grout gun and squeeze the grout into the joints between the thin-adhered masonry units. Once the mortar is thumbprint hard, tool the joints to a concave or raked finish depending on the desired joint finish ensuring to push the mortar into the joint during this process to force the mortar against the adhered veneer units. Allow the wall to cure.

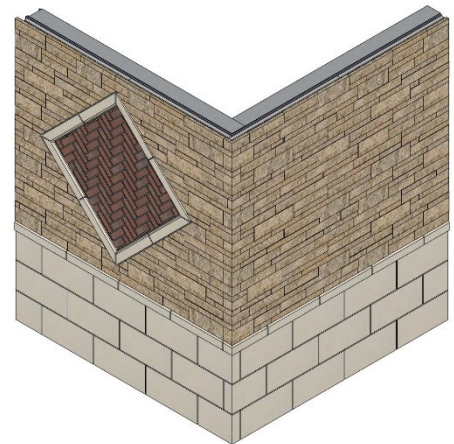

ProGUARD DP® Corner Installation Guide (option2) (Steel Stud Substrate)

| Checklist for Placing a Supported or Unsupported ProGUARD DP® Panel Order | | | |
|--|---|---|--|
| Materials Required | | Approximate Coverage/Size (if applicable) | Notes |
| <input type="checkbox"/> | ProGUARD DP® Water Armor Flashing Tape or Laticrete Waterproofing Anti-Fracture Fabric | Water Armor - 4", 6", or 9" x 180'-0" (covers the joints of approximately 15 full 4'-0" x 8'-0" sheathing panels) Laticrete - 6" x 75'-0" (covers the joints of approximately 6 full 4'-0" x 8'-0" sheathing panels) | Does not account for windows, sheathing panels that have been cut etc... For the price we simply recommend doubling the quantities |
| <input type="checkbox"/> | Water Armor Air and Water Barrier (an Air and Water Barrier that is Vapor Permeable with a perm rating of 30) or Water Armor VB (a Vapor Barrier with a perm rating of 0.07) or Laticrete Air and Water Barrier (an Air and Water Barrier that is a Vapor Retarder with a perm rating of 0.157) or Laticrete Air Barrier C3 (an Air and Water Barrier that is a Vapor Permeable with a perm rating of 3.0) | 500 sq. ft. with 1 coat required 250 sq. ft. with 2 coats required 250 sq. ft. with 2 coats required 500 sq. ft. with 1 coat required | |
| <input type="checkbox"/> | 16 Gauge Steel Flashing/Panel Support (supplied by others) Eliminate these for an Unsupported Assembly | Match lineal footage of Base Weep Panels if required for a Supported Assembly | |
| <input type="checkbox"/> | Water Armor LF or Laticrete Flashing Sealant | 16 lin. ft. 16 lin. ft. | |
| <input type="checkbox"/> | ProGUARD DP® Base Weep Panels (for base of walls, at deflection joints, over openings etc...) | 8 sq. ft. (or 8'-0" lineal feet) | |
| <input type="checkbox"/> | ProGUARD DP® Panels (3'-0" x 8'-0" with EPS/XPS insulation) or ProGUARD DP® Panels (3'-0" x 4'-0" with Mineral Wool Insulation) | 24 sq. ft. 12 sq. ft. | |
| <input type="checkbox"/> | ProGUARD DP® Silver C Screws Remember to order screws for attaching the ProGUARD DP® panels as well as the shorter versions (1-1/2" or 2") for attaching the 16 Gauge Steel Flashing/Panel Support if they are being incorporated into the design. | Dependent on required spacing and determined by the engineer of record. Sold in full box quantities. Screw length should ensure a minimum 1" embedment into studs (i.e. ProGUARD DP® thickness plus exterior grade sheathing thickness plus 1" – select next longest standard fixed screw length) | Assume 50 screws per ProGUARD DP® panel and 20 screws per Base Weep Panel (BWP) |
| <input type="checkbox"/> | ProGUARD DP® Silver C Non-Barb Plate Washers (Galvanized) NOTE: WASHERS ARE ONLY TO BE USED IN COMBINATION WITH THE SCREWS IN THE VERTICAL JOINTS BETWEEN PANELS. WASHERS USED IN ANY OTHER LOCATION WITHIN THE ASSEMBLY WILL VOID THE PRODUCT SPECIFIC MATERIAL AND SYSTEM WARRANTIES. | 100 or 1000 Count boxes (dependent on required spacing of screws) | Assume 7 washers per ProGUARD DP® panel and 2 washers per Base Weep Panel (BWP) |
| <input type="checkbox"/> | Sikaflex 11FC polyurethane sealant and concrete board strips | Sikaflex: 9 lin. ft. Strips: ¼" x 3'-0" x ProGUARD DP® thickness | For all exposed insulation surfaces at corners and windows. |
| <input type="checkbox"/> | Alkali Resistant Mesh Tape Rolls | 4" x 150'-0" (covers the joints of approximately 13 full 3'-0" x 8'-0" ProGUARD DP® panels) | Does not account for windows, ProGUARD DP® panels that have been cut etc... Double quantities |
| <input type="checkbox"/> | Thin Masonry Veneer Material (stretchers, corners, custom profiles) | Dependent on selected material | |
| <input type="checkbox"/> | T.Clear Total Bond for all masonry options or Laticrete Bonding Mortar (select appropriate one): 1) Laticrete Hi-Bond Masonry Veneer Mortar for ARRIS-tile, Porcelain tile, ceramic tile natural stone tile, or 2) Laticrete Masonry Veneer Mortar for manufactured stone and thin natural building stone, or 3) Laticrete Thin-Brick Mortar for thin brick, Midtown, Coastal and Stack | 25 sq. ft. 25 sq. ft. 25 sq. ft. 25 sq. ft. | |
| <input type="checkbox"/> | Shims (to help with proper install and keep stone and joints level as material is installed and to maintain joint spacing): 1) 1/16" (100 per bag) 2) 1/8" (100 per bag) 3) 1/4" (100 per bag) 4) 3/8" (20 per bag) | Order shim thickness that is appropriate for the joint widths for the masonry material being installed. Exception to that rule, we recommend 1/16" and 1/8" shims be used with Stack and Midtown when installing them with tight joints. | |
| <input type="checkbox"/> | Laticrete Pointing Mortar or Type N mortar to point the joints (if required) | Dependent on selected material | |
| <input type="checkbox"/> | Laticrete Latasil or Dowsil Silicone Sealant for sealing movement joints and joints around openings such as windows and doors, as well as penetrations like pipes and fittings etc... (don't forget the backer rod in the joint prior to installing the silicone) | Dependent on Joint width to be sealed | |